

DS-215 Bed Scale

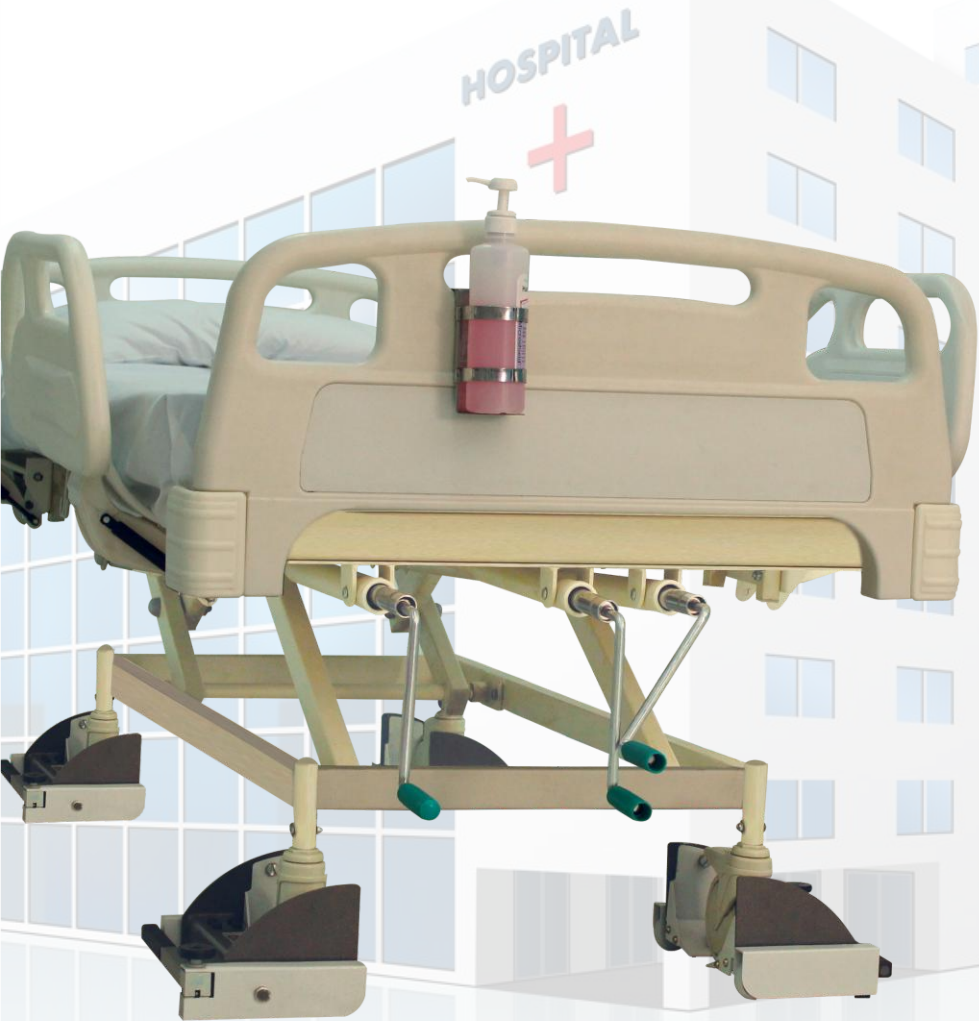

Portable Bed Scale, ideal for Weighment in the Healthcare Industry

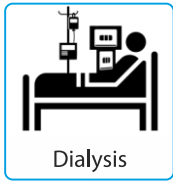
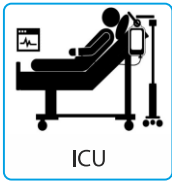

Technical Specification

Capacity	200 kg
Accuracy / Readability	100 g
Keys	5 keys
Battery	6 V/4 Ah
Display	20 mm Large Green LED Display
Functions	Tare, Digital Tare & Pause
Load Cell Kit	<ul style="list-style-type: none"> • 4 x Integrated lifting mechanism • MOC : MS Powder Coated • Dimension : 330 (L) x 234 (W) x 152 (H) mm
Trolley	<ul style="list-style-type: none"> • Mobile Trolley with Integrated Display & Charger • Wheel with brakes • Light Weight • MOC : Aluminum
Castor Wheel Dimensions (Dia)	<ul style="list-style-type: none"> • Minimum : 75 mm • Maximum : 200 mm • Maximum Thickness : 90 mm

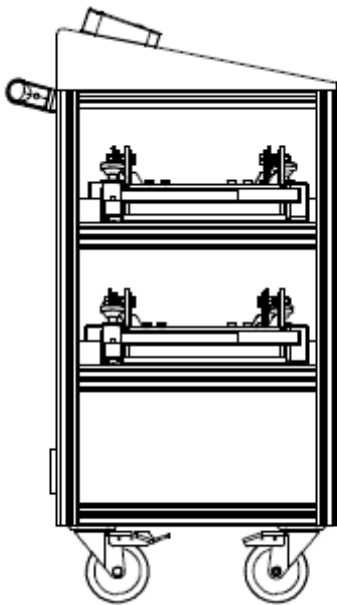
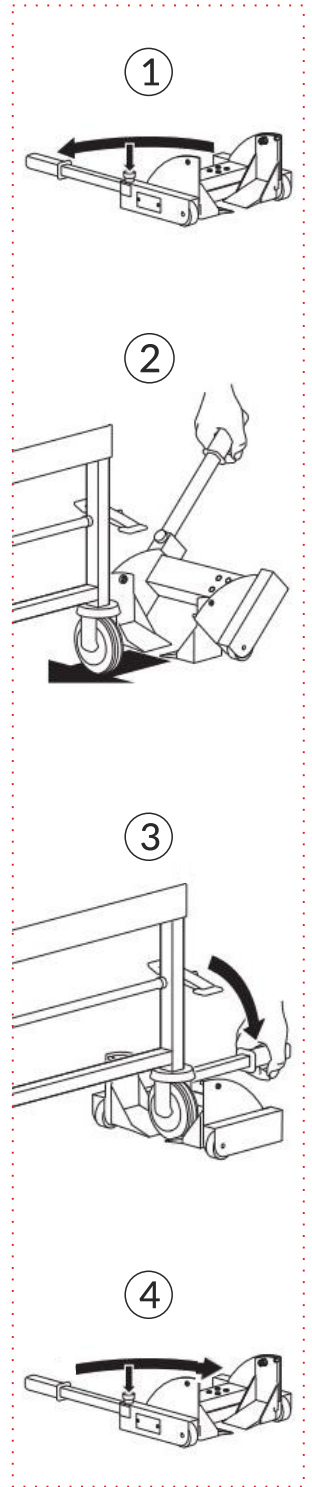

Trolley

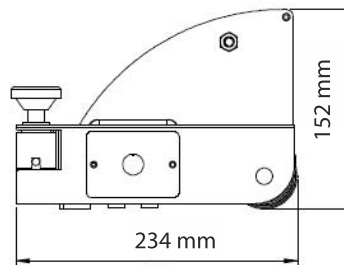
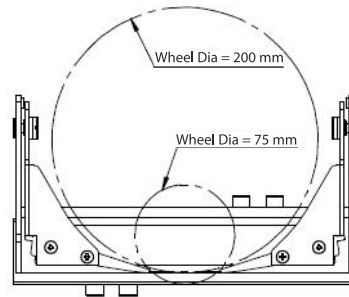

Load Cell kit

Operation

Form No.CAT-DS-215 Bed Scale-057 R00

Essae-Teraoka Pvt. Ltd.

410, 100ft Road, 4th Block,
Koramangala, Bengaluru-560 034
info@essae.com
http://www.essae.com

+91 80 3021 3021
+91 80 3021 3001
1-800-425-3111
0-78488 12346

Essae[®]
...for Excellence

Your Essae representative

▲ Factories in Bengaluru and Goa ▲ 45 Branch Offices ▲ 250+ Service engineers ▲ 350+ Resellers/Partners

Note: The above model meets the statutory and regulatory requirements as per the provision of legal metrology Act 2009 and legal metrology (General) Rule, 2011. Specifications are subject to change without notice. Other names and logos used are property of respective brands.